

護国 箱棟シリーズ 組立図

これは組み立ての一例です。各現場により適時お考えのうえ施工してください。

W-25型

◎ W-75型, W-95型の施工例の一例は裏面をご覧ください。

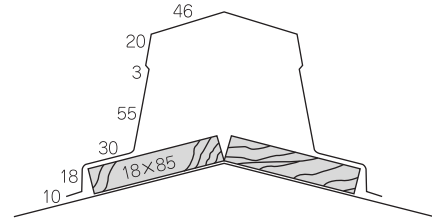
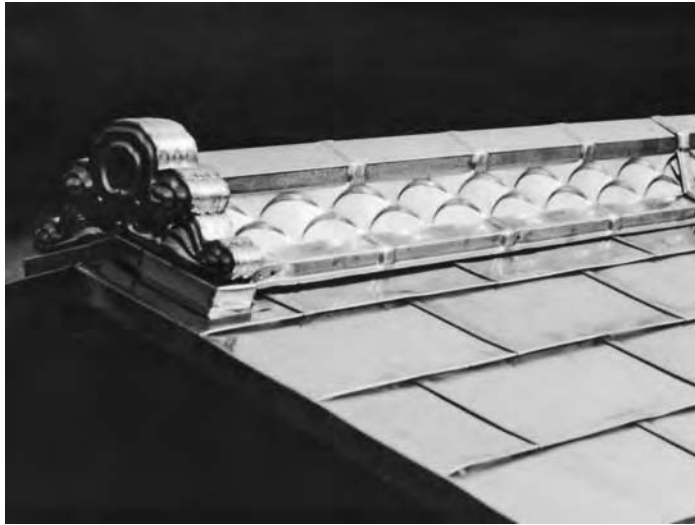

取付の際は、木ネジ又はスクリュー釘をご使用ください。

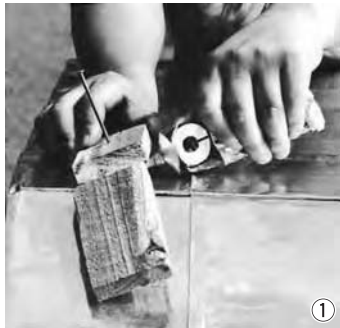

コーキングを忘れずに

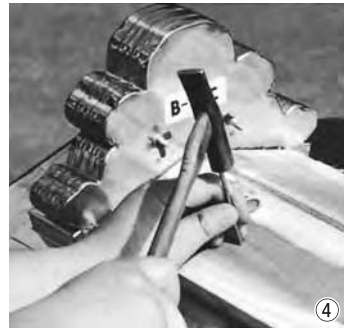

コーキングを忘れずに

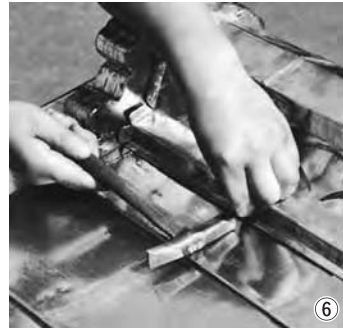
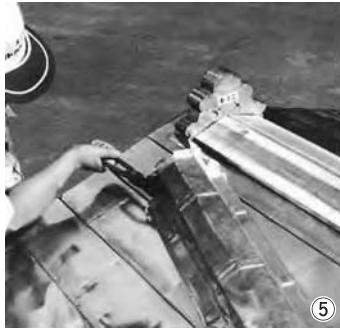

コーキングを忘れずに



コーキングを忘れずに

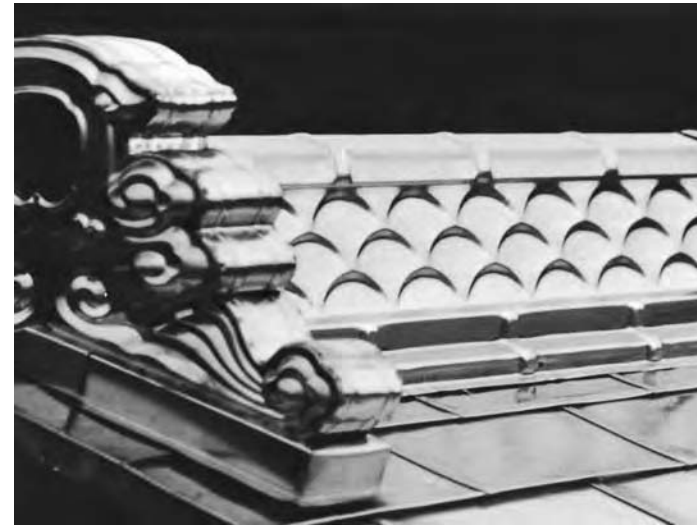

W-55型

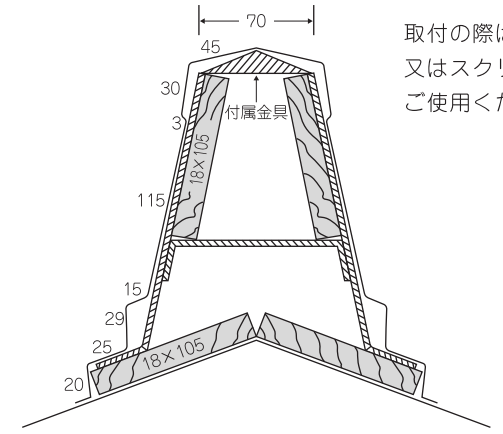

取付の際は、木ネジ又はスクリュー釘をご使用ください。

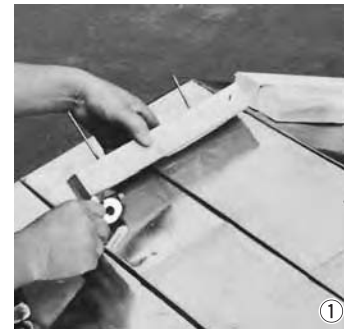

コーキングを忘れずに

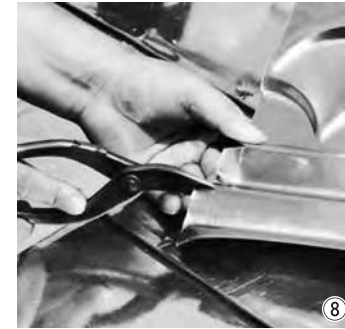
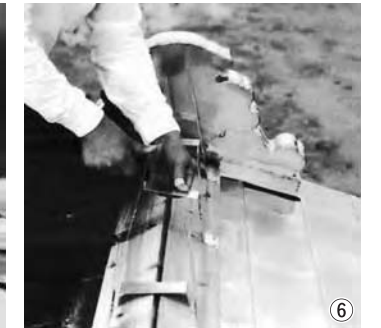
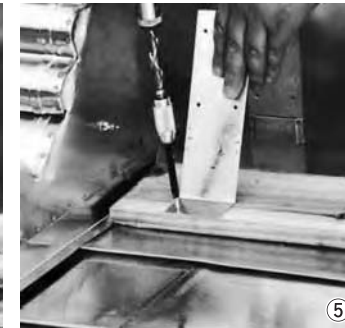
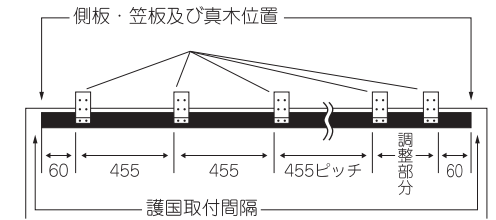
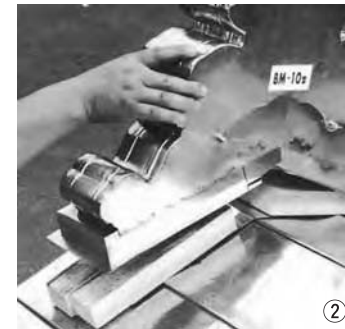

コーキングを忘れずに



合せ目にコーキングを忘れずに

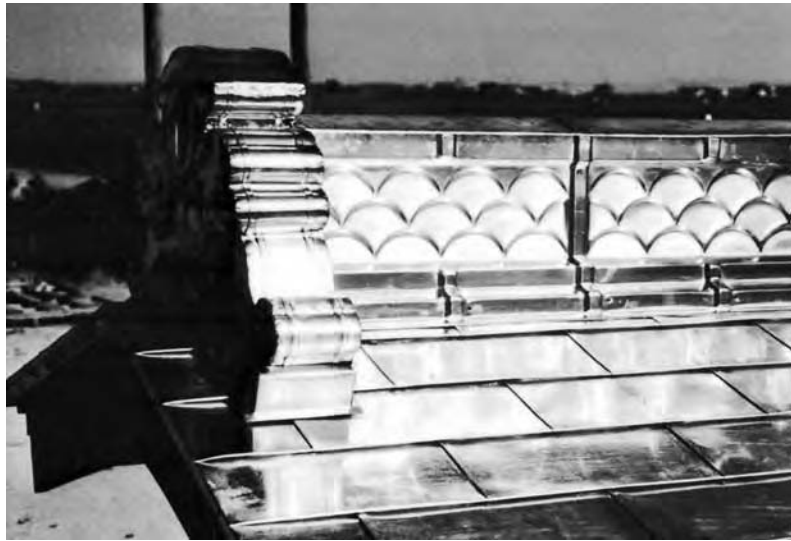

W-75型・W-95型

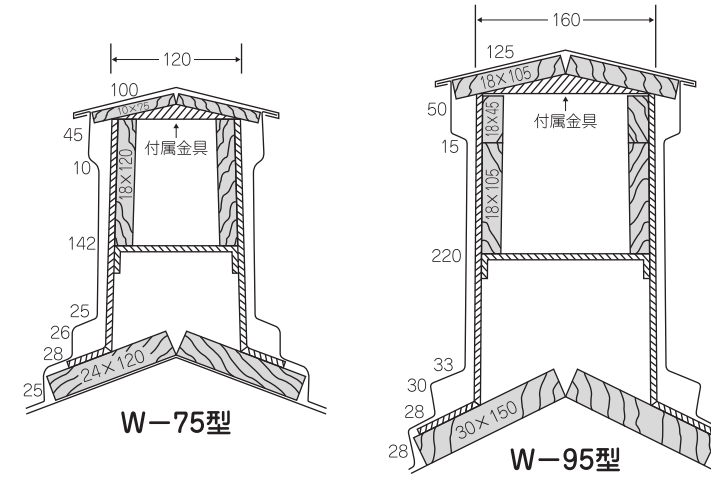
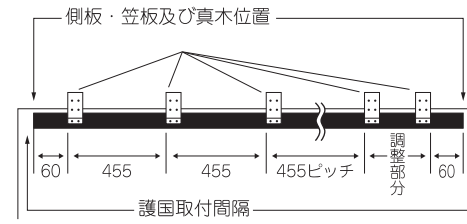

取付の際は、木ネジ又はスクリュー釘をご使用ください。



コーキングを忘れずに

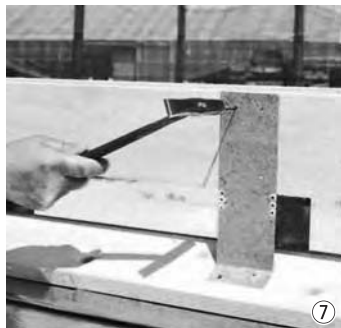

コーキングを忘れずに



コーキングを忘れずに



コーキングを忘れずに

鬼を棟木に固定する方法の一例

下図の施工方法を行った上、W-25型・W-55型・W-75型・W-95型の説明の施工を併用された方がより一層強度が増します。

